

METHVEN

AIO AURAJET RAIL SHOWER

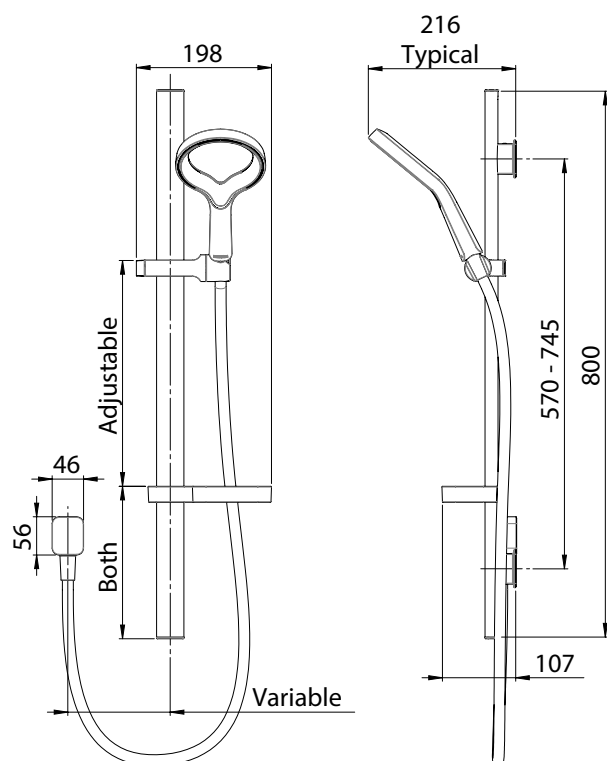

SPECIFICATIONS

Recommended Use	Domestic, hotel and commercial
Colour	Matte Black
Pressure Rating	Suitable for high pressure applications and has been WELS certified to the following: Minimum operating pressure 150kPa Maximum operating pressure 500kPa
Temperature Rating	Maximum continuous working temperature 70°C (recommended 38°C - 42°C) Minimum 1°C
Suitable Hot Water Units	Storage Tank: Yes Continuous Flow: Yes Gravity Feed: Not recommended
WELS	Stars: 3 Flow rate: 9L/min
Standards	AS/NZS 3662
Spray Patterns	Aurajet Spray



To see the complete AIO range go to www.reece.com.au/bathrooms

CLEANING RECOMMENDATIONS

We recommend the use of soapy water or approved cleaners. This product should not be cleaned with abrasive materials. Damage caused by improper treatment is not covered by the product warranty – refer to warranty conditions.



Disclaimer: Products in this specification manual must by regulation be installed by licensed and registered trade people. The manufacturer/distributor reserves the right to vary specifications or delete models from their range without prior notification. Dimensions are nominal measurements only. Dimensions and set-outs listed are correct at time of publication however the manufacturer/distributor takes no responsibility for printing errors.

Tech Page Version 1

METHVEN

reece

METHVEN

AIO AURAJET RAIL SHOWER

INSTALLATION INSTRUCTIONS

Step 1

- Mount the wall boss housings in desired position with the screws. Check the mounts are vertically aligned. Ensure the grub screws are located on the correct sides as shown.

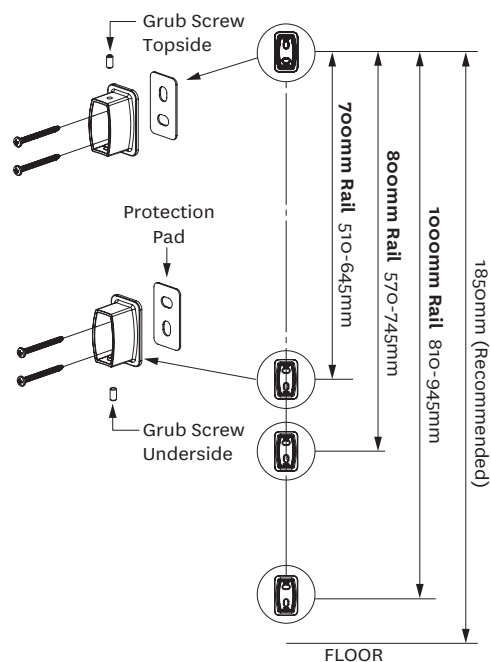

Step 2

- Slide soap dish onto the rail

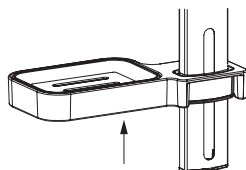

Step 3

- Fit the internal mounting brackets by locating in slot and rotating 90°.

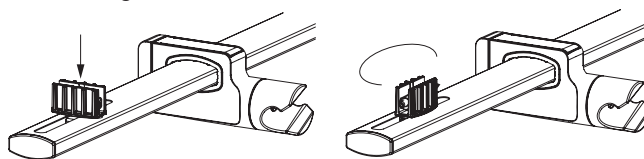

Step 4

- Tighten the tensioning screws lightly with the hex key provided. Rail can be oriented so that handset sits on opposite side of rail.

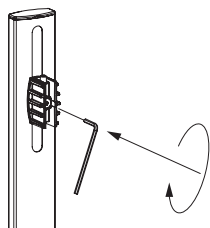

Step 5

- Match the mounting brackets to wall bosses and push into place.
- Slide rail up or down to centralise the brackets
- Remove the rail and tighten the tensioning screws firmly.
- Relocate the rail onto wall bosses and tighten grub screws top and bottom.

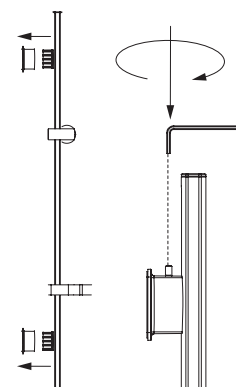

Step 6

- To adjust slider position, rotate the slider handle to unlock and lock the slider as shown.

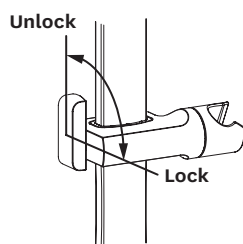

METHVEN

AIO AURAJET RAIL SHOWER

INSTALLATION INSTRUCTIONS

Elbow Installation:

Step 1

- Wall lining hole should be cut or finished as per the dimension shown in the diagram on the right
- Cut off the threaded nipple $13\pm 2\text{mm}$ from the wall lining and apply thread seal tape to ensure a good seal.

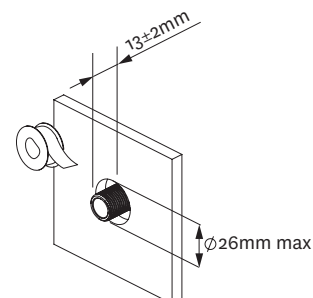

Step 2

- Screw the elbow onto the nipple ensuring that the o-ring is sufficiently compressed to create a watertight seal.
- Ensure that the elbow is oriented vertically with the outlet oriented downwards.

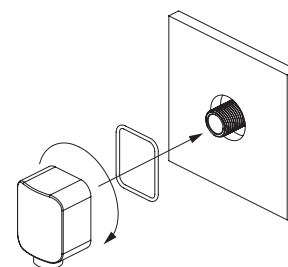

Step 3

- Connect hose to elbow and handset
- Ensure swivelling cone is connected to the handset

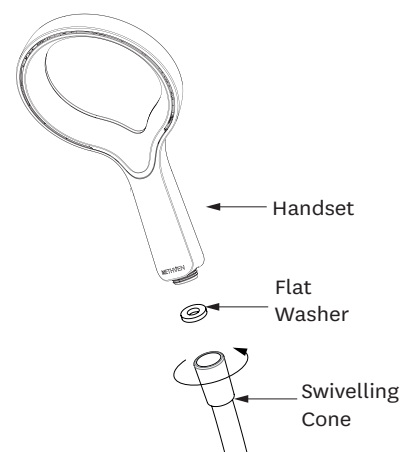

Care and Cleaning

We recommend the use of soapy water or approved cleaners. This product should not be cleaned with abrasive materials. Damage caused by improper treatment is not covered by the product warranty – refer to warranty conditions on the last page.

A filter washer should be installed in the hose cone on the water outlet and it should be cleaned periodically.

If shower performance is compromised by the build-up of lime-scale, clean by using a soft toothbrush and gently scrubbing along the spray slot under running water.

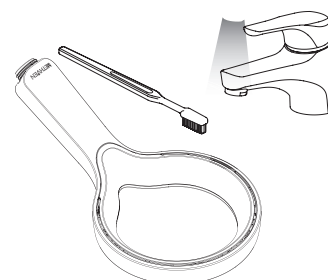
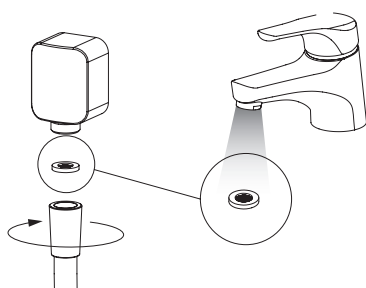

Plumbers, please ensure a copy of the installation instructions is left with the end user for future reference

METHVEN

reece