

NOBILI

ACQUARIO BASIN MIXER

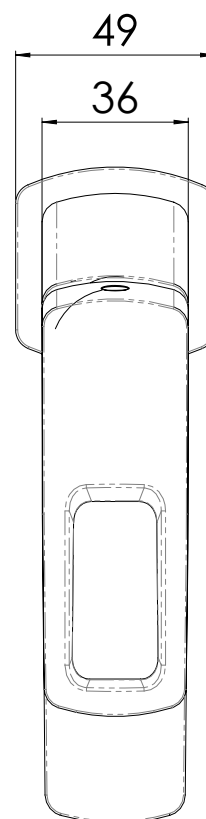
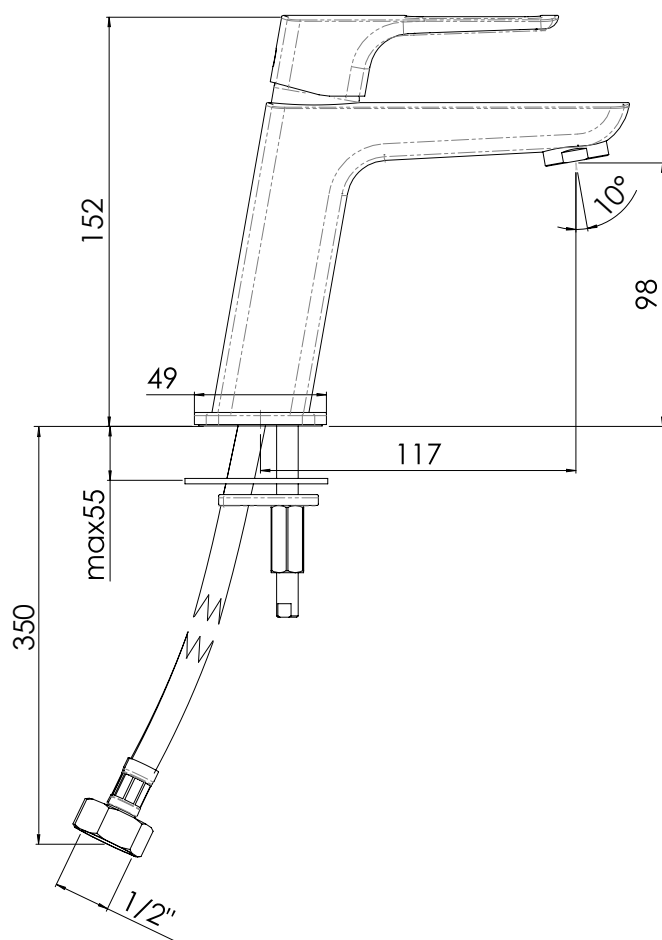

Dimensions are nominal measurements only.

SPECIFICATIONS

Recommended use	Domestic, hotel and commercial
Colour	Chrome
Pressure rating	Minimum continuous working pressure 50 kPa Maximum continuous working pressure 1000 kPa For best performance and longer life we recommend 150-500kPa
Temperature rating	Maximum recommended working temperature 65°
Suitable Hot Water Units	Storage tank: Yes Continuous Flow: Yes Gravity Feed: Not recommended



To see the complete NOBILI range go to www.reece.com.au/bathrooms

CLEANING RECOMMENDATIONS

We recommend the use of soapy water or approved cleaners.

This product should not be cleaned with abrasive materials.

Damage caused by any improper treatment is not covered by the product warranty. Refer to Warranty Conditions.

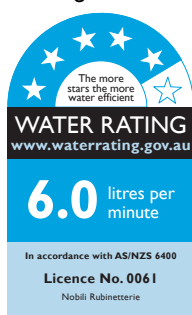

Disclaimer: Products in this specification manual must by regulation be installed by licensed and registered trade people. The manufacturer/distributor reserves the right to vary specifications or delete models from their range without prior notification. Dimensions are nominal measurements only. Dimensions and set-outs listed are correct at time of publication however the manufacturer/distributor takes no responsibility for printing errors.

Tech Page Version 1

NOBILI  **reece** 

NOBILI

ACQUARIO BASIN MIXER

INSTALLATION INSTRUCTIONS

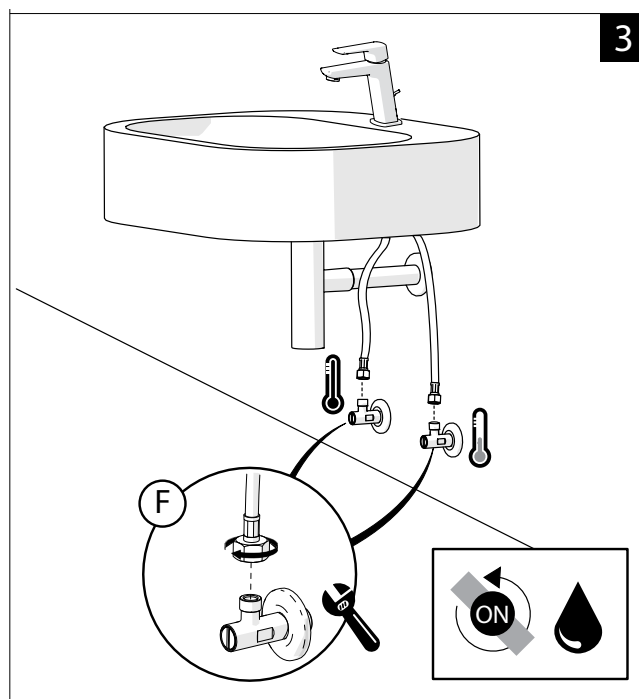
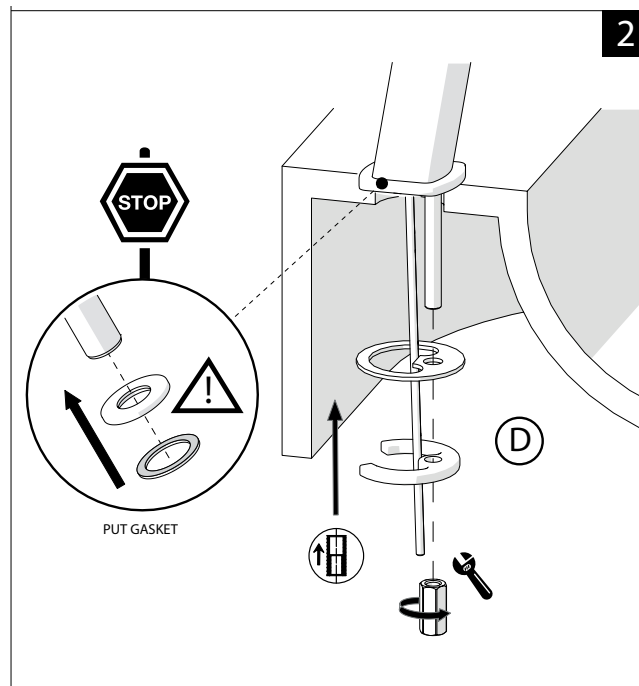
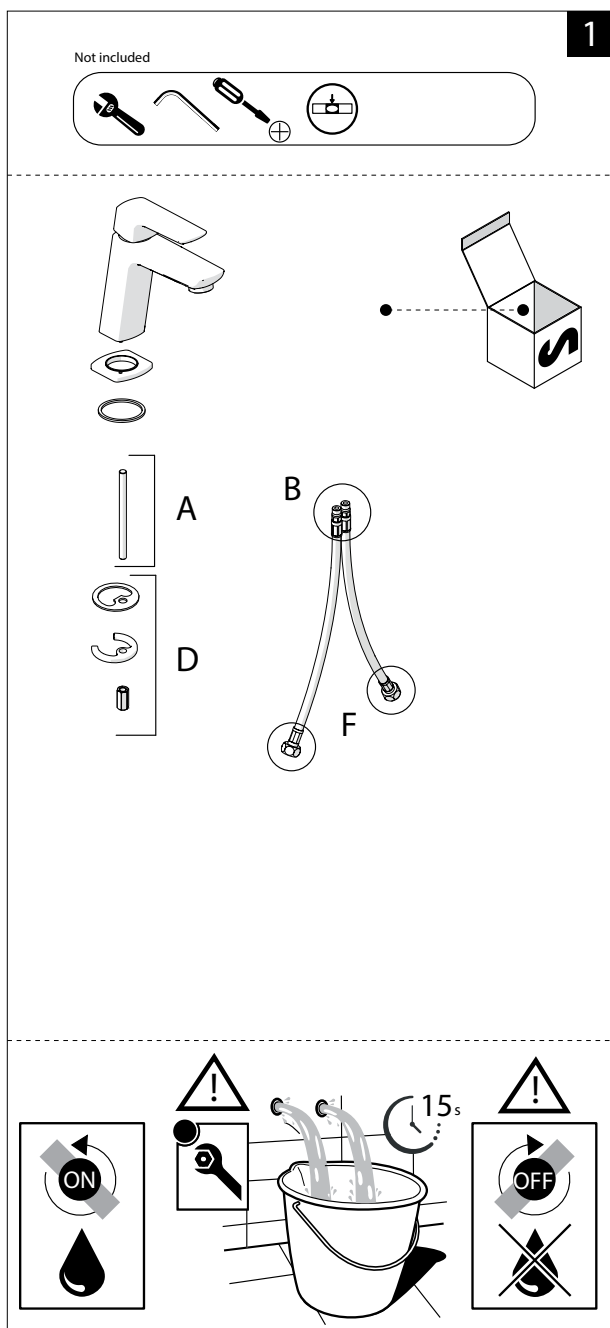

NOBILI

ACQUARIO BASIN MIXER

INSTALLATION INSTRUCTIONS

-50%

"Dinamic" flow rate restrictor "50%"

CLOSE



Closed position

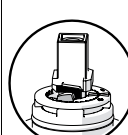

ECO

ON 50%



Position of water saving "50% capacity"

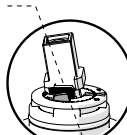

ON 100%



100% Fully open flow



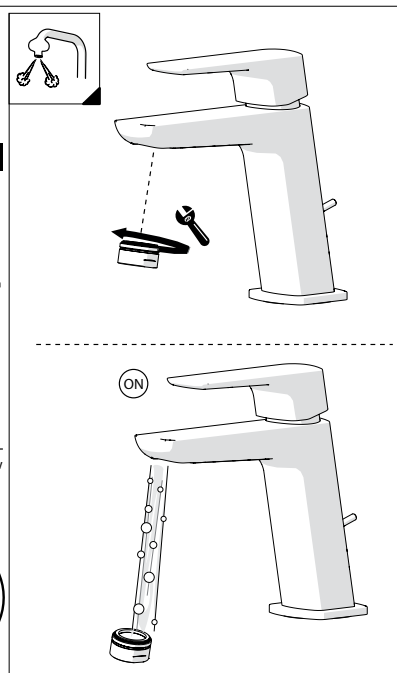

4

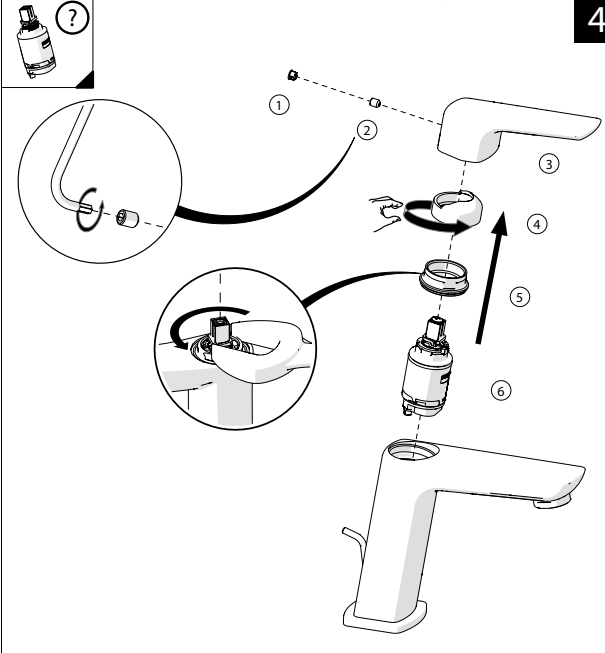

5

Extract the limiter and put it in correct position to limit temperature

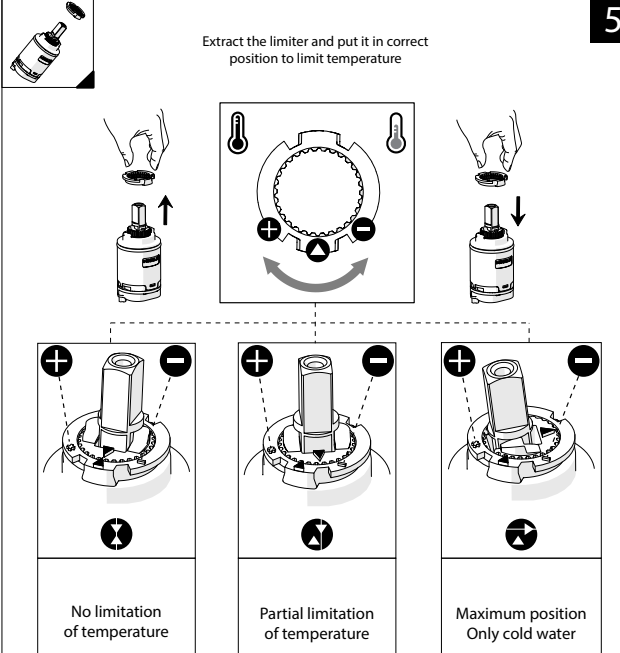

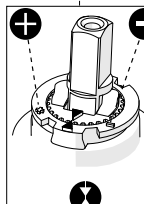

No limitation of temperature

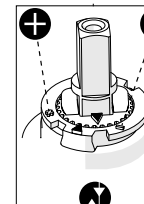



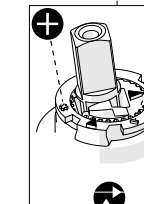





Partial limitation of temperature













Maximum position Only cold water

BEFORE STARTING

	P bar		MAX 10 0.5 MIN		5 1		T		T ∞ C		MAX 80		65 45	
---	----------	---	-------------------------	---	--------	---	---	---	-------------	---	-----------	--	----------	---

CLEANING

				
WATER 	ALCOHOL 	MICROFIBER 	SPONGE 	DETERGENT 

Plumbers, please ensure a copy of the installation instructions is left with the end user for future reference