

Kaldewei Puro Duo 1800x800x420 with Overflow Chrome

AUSTRALIAN BATH & SHOWER FLOOR INSTALLATION

Australian Standard 2023/1995 Section 1.5 specifies, "A built-in bath shall be provided with a tiling flange or bead not less than 10mm in height".

When handling steel enamel baths, care must be taken that they are treated correctly. This applies to their transport, unpacking and installation.

Kaldewei recommends that baths be fitted during the final installation and that the bath be covered until all the building work has been completed.

This bath has been supplied with sufficient high impact rigid PVC modified grade material to allow, where necessary, for the bath to be flashed along the full length and ends to conform with the Australian standard.

This clip on material should be cut to the required lengths, mitered at the corners, and the area where the flashing material and the rim of the bath meet, should be filled with a mould-resistant Sanitary Grade sealant.

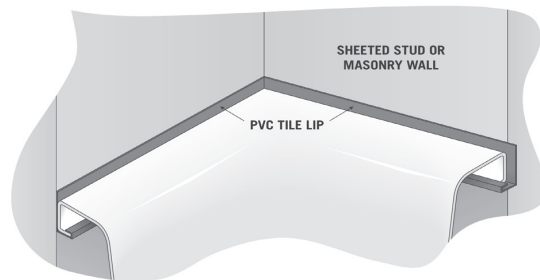
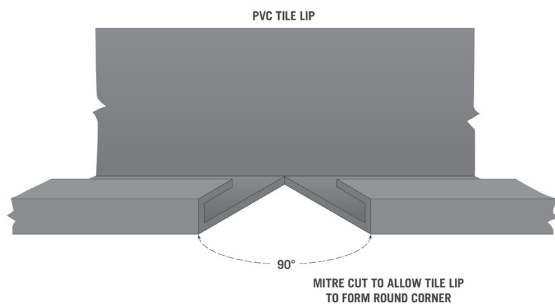

When the bath is installed, the minimum distance from the outside edge of the flange to the finished edge of the tiles shall be 10mm. The exposed area of the flange shall have continuous fall to the inside of the bath.

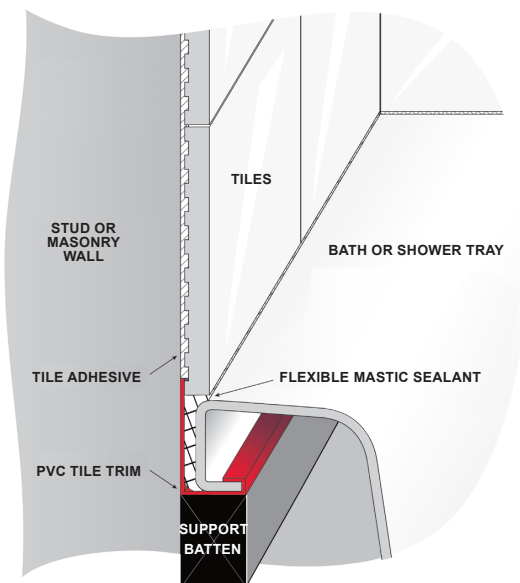

REFERENCES

Australian Standards AS. 3470-2010

Fig 3.2 Typical Bath Junctions

Section 3. Installations 3.6 Pre Formed Shower Bases

3.7 Baths with showers over them

3.8 Baths and Spas

Plumbers, please ensure a copy of the Installation Instructions are left with the end user for future reference

Kaldewei Puro Duo 1800x800x420 with Overflow Chrome

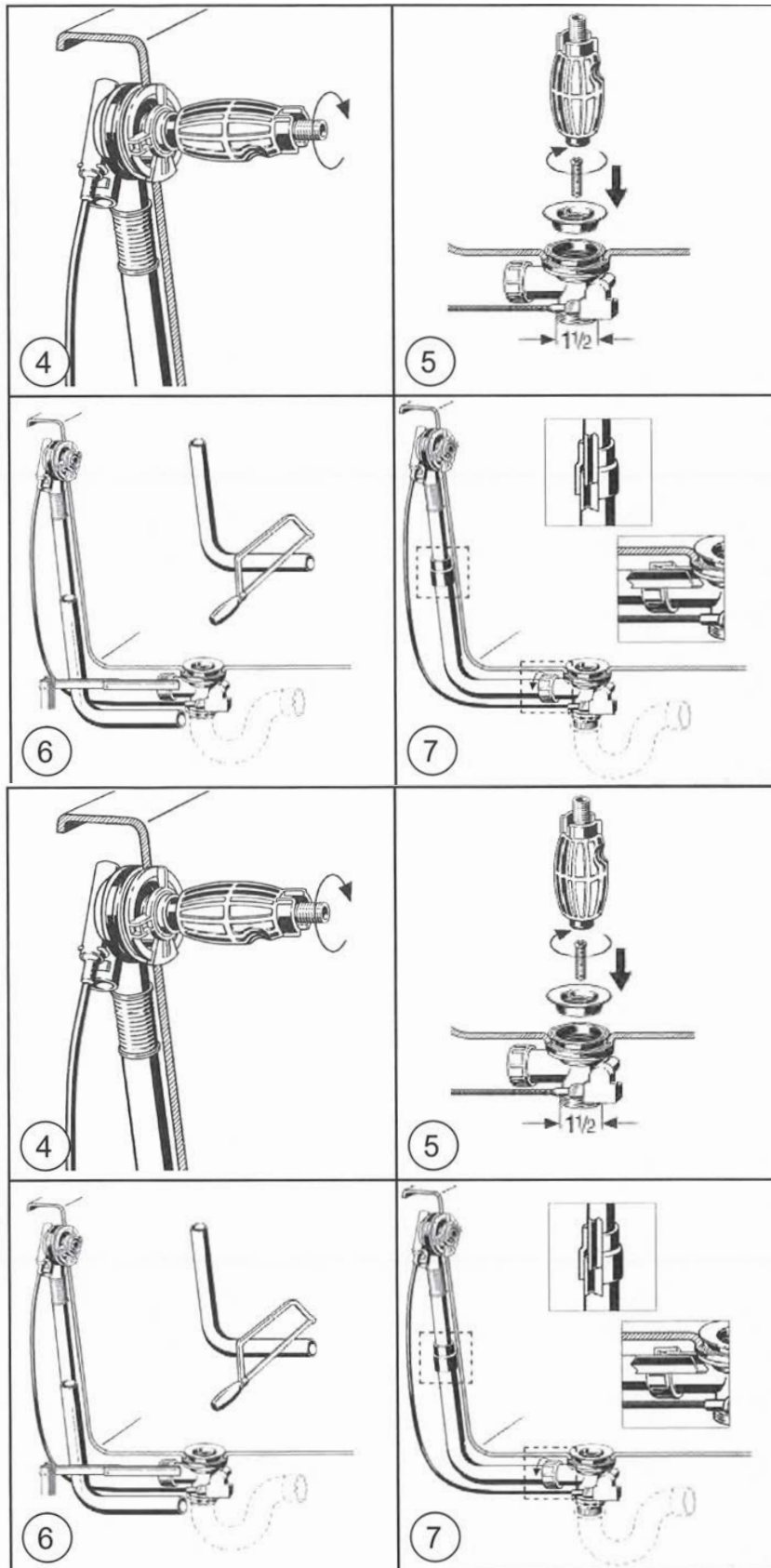

Plumbers, please ensure a copy of the Installation Instructions are left with the end user for future reference

Kaldewei Puro Duo 1800x800x420 with Overflow Chrome

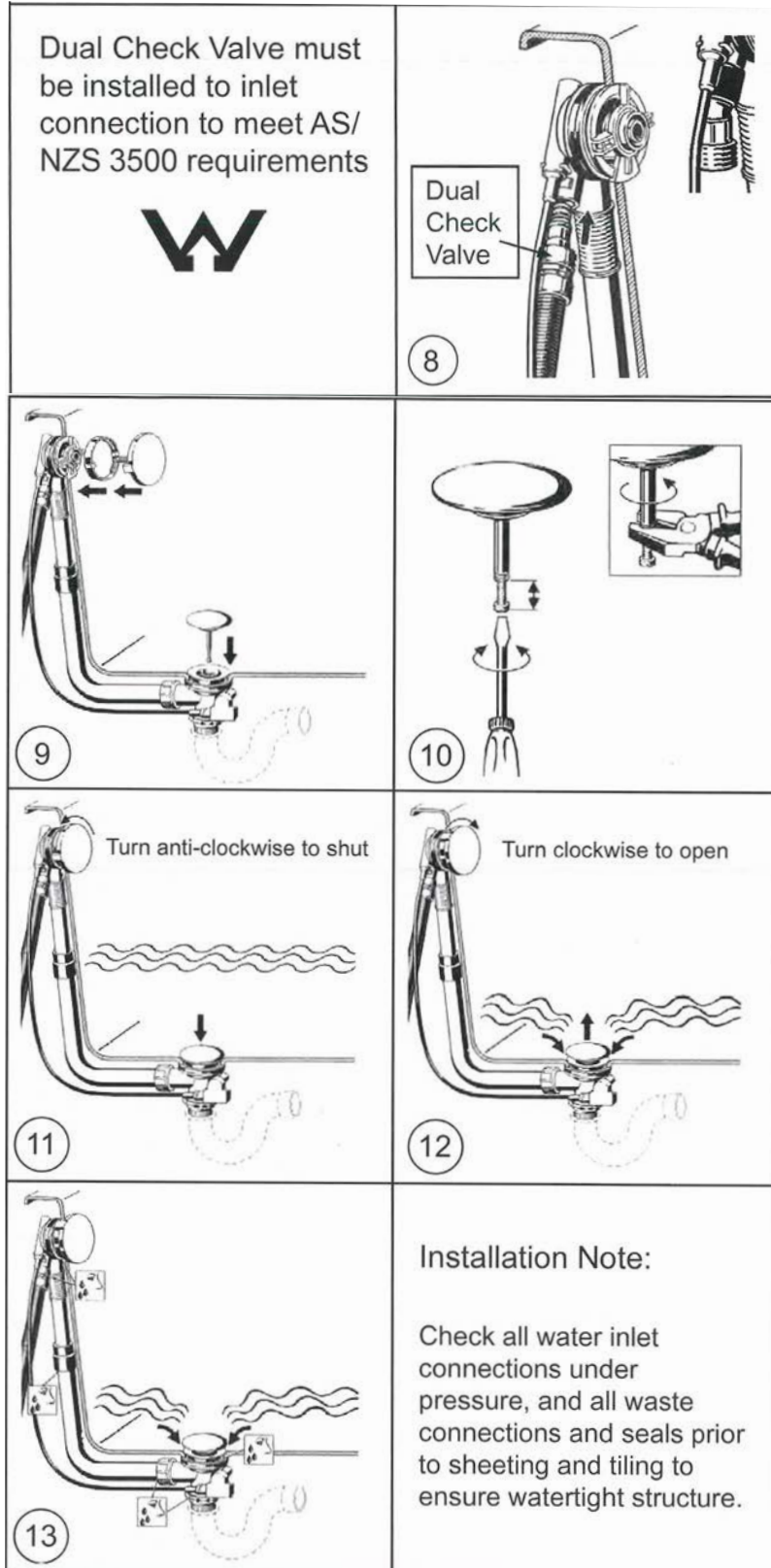

Plumbers, please ensure a copy of the Installation Instructions are left with the end user for future reference