

ISSY

Halo II Vanity Unit



SPECIFICATIONS

Recommended Use	Domestic, Hotel & Commercial
Vanity Cabinet Material	American Oak veneer (19mm)
Vanity Frame Material	2 Pack Polyurethane on High Moisture Resistant MDF
Drawer Design	Touch release drawer/s opening with soft close drawer/s
Benchtop Material	Corian (12mm)
Colour Variations (Prices may vary)	Please refer to the Colour, Finish and Material Variations Document on the Website for more information.
Fixing	Bolted / Screwed to Wall by a Licensed Trades Person (not included)
Basin	Sold Separately, refer to Brochure
Tapware	Sold Separately. Compatible with Wall mounted tapware



To see the complete Issy range go to www.reece.com.au/bathrooms

STANDARD SIZES	H2-VU500	H2-VU600	H2-VU1000	H2-VU1200	H2-VU1500	H2-VU1800
Width (mm)	500	600	1000	1200	1500	1800
Depth (mm)	450	450	450	450	450	450
Height (mm)	320	320	320	320	320	320
Number of Drawers	1	1	2	2	3	3
Basin Options	1	1	1	1	1-2	1-2

CUSTOM SIZES	H2-VU501-600	H2-VU601-800	H2-VU801-1100	H2-VU1101-1300	H2-VU1301-1600	H2-VU1601-1800	H2-VU1801-2000
Width (mm)	501-601	601-800	801-1100	1101-1300	1301-1600	1601-1800	1801-2000
Depth (mm)	400-500	400-500	400-500	400-500	400-500	400-500	400-500
Height (mm)	320	320	320	320	320	320	320
Number of Drawers	1	1	2	2	4	4	4
Basin Options	1	1	1	1	1-2	1-2	1-2

Disclaimer: Products in this specification manual must by regulation be installed by licensed and registered trade people. The manufacturer/distributor reserves the right to vary specifications or delete models from their range without prior notification. Dimensions are nominal measurements only. Dimensions and set-outs listed are correct at time of publication however the manufacturer/distributor takes no responsibility for printing errors.

Published 16/02/2024



ISSY

Halo II Vanity Unit

STANDARD SIZES
TOUCH RELEASE DRAWER/S OPENING

500mm

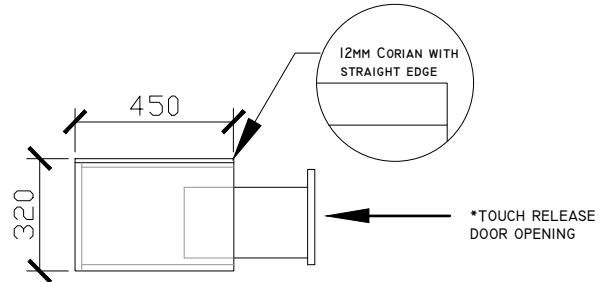
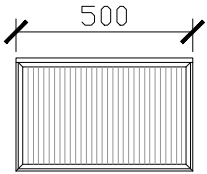

**SLIM DRAWER

SIDE VIEW for all sizes

600mm

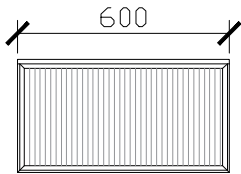

1000mm

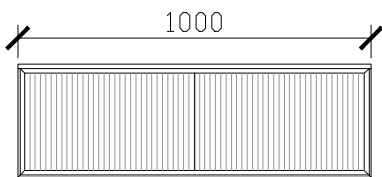

1200mm

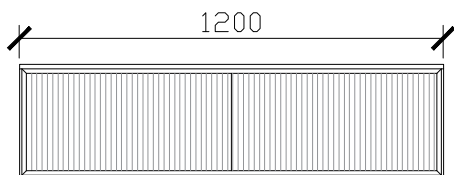

ISSY

Halo II Vanity Unit

STANDARD SIZES
TOUCH RELEASE DRAWER/S OPENING

1500mm

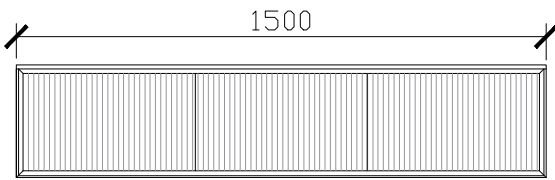

1800mm

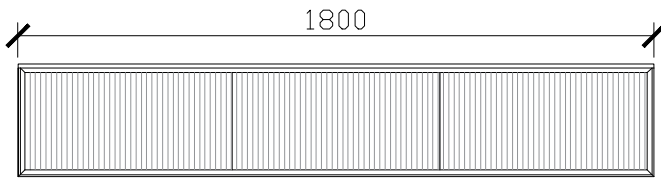

ISSY

Halo II Vanity Unit

CUSTOM SIZES
TOUCH RELEASE DRAWER/S OPENING

INTERNAL VIEW for all sizes

501-600mm

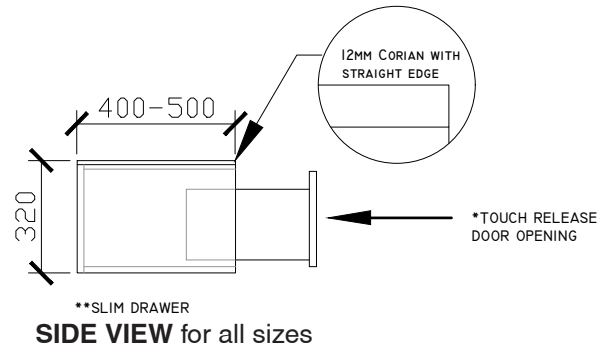
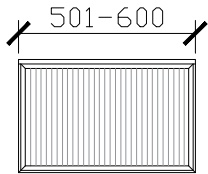

601-800mm

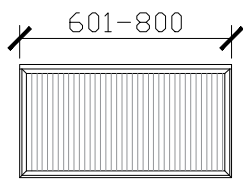

801-1100mm

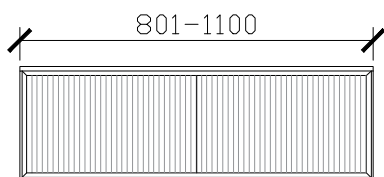

1101-1300mm

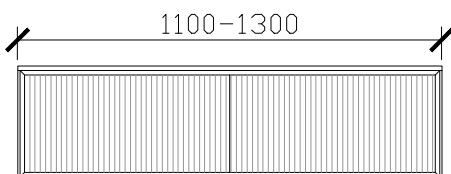

ISSY

Halo II Vanity Unit

CUSTOM SIZES
TOUCH RELEASE DRAWER/S OPENING

1301-1600mm

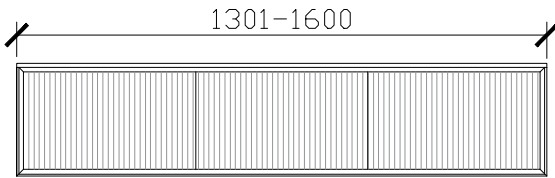

1601-1800mm

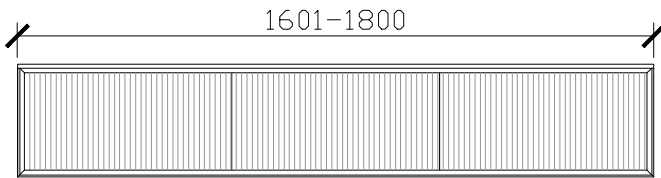

1801-2000mm

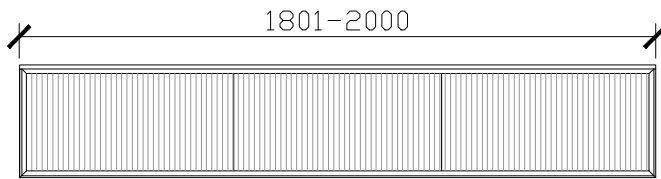

Halo II Vanity Unit

STANDARD - RECOMMENDED FOR COUNTER BASINS
120DIA CORIAN CUTOUT

500 - 600W: CENTRAL ONLY

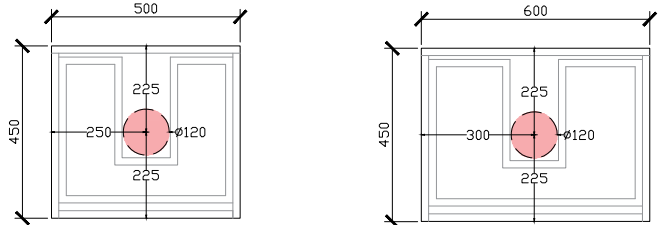

1000W: CENTRE VOID | OFFSET LEFT & RIGHT

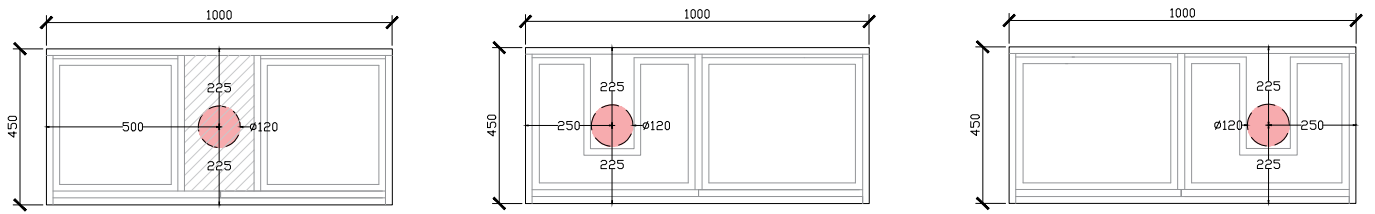

1200W: CENTRE VOID | OFFSET LEFT & RIGHT

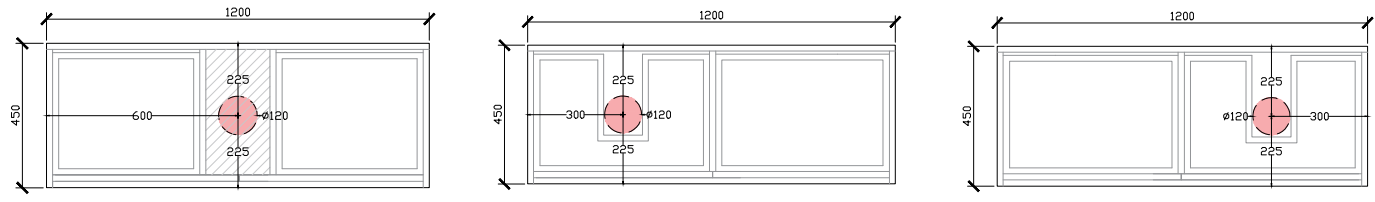

1500W: CENTRAL & DOUBLE BASIN | OFFSET LEFT & RIGHT

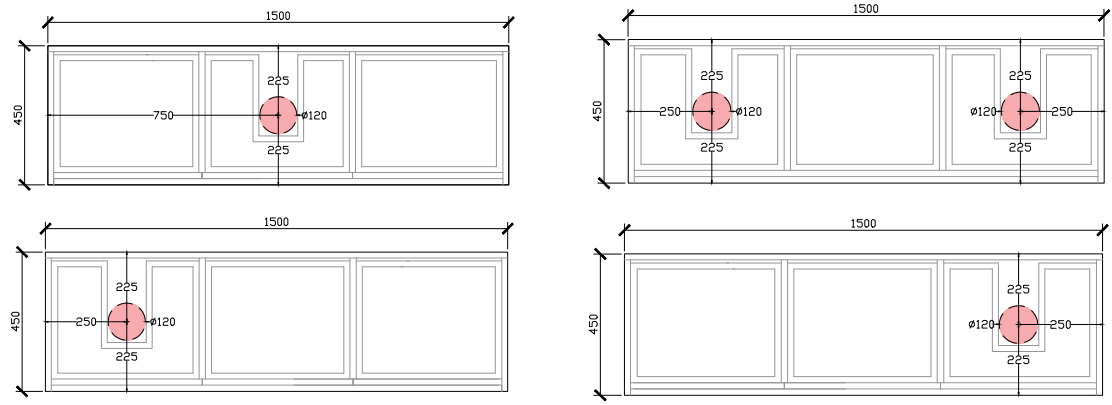

ISSY

Halo II Vanity Unit

STANDARD - RECOMMENDED FOR COUNTER BASINS
120DIA CORIAN CUTOUT

1800W: CENTRAL & DOUBLE BASIN | OFFSET LEFT & RIGHT

